

ENDVERBINDER
END CONNECTOR

30

5 8E 8 8S 10

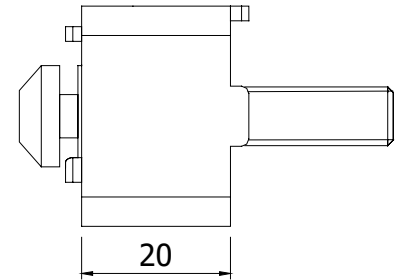
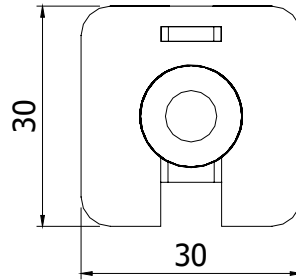

Bevat / consists:

- Basis / basic unit
- Kopbout / head bolt
- Bout / bolt
- Veer / spring
- Stelschroef / setscrew

Materiaal / material:

- GD-Zn

Kenmerk / features:

- Eenvoudige verbinding zonder boring in het profiel / easy to connect, without work on profile
- Eenvoudig aandraaien door fixerende stelschroef / easy to screw in self-tapping connecting screws
- Biedt mogelijkheid tot plaatsen voor plaatsen van panelen in de sleuf / attachment of panel elements

Toepassing / application

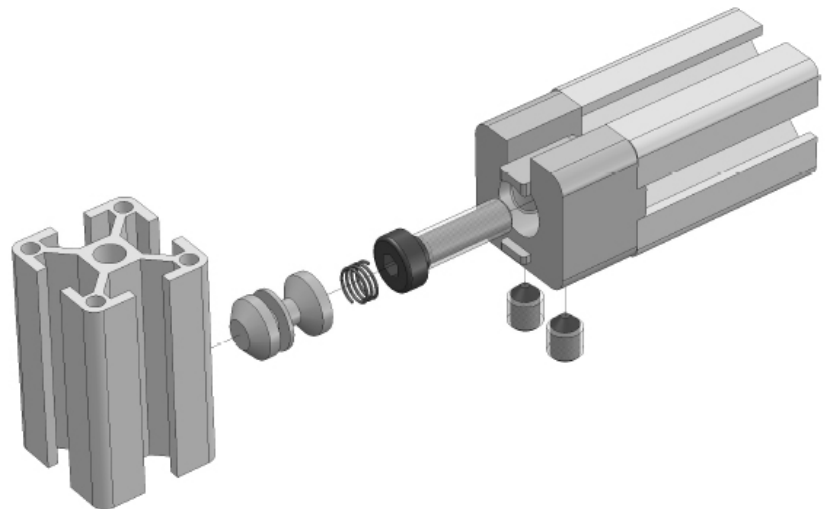

Afname / purchase	Korting / discount
... stuks / piece	
50 stuks / pieces	10%

Omschrijving / description	Eenheid / unit	Art. code
Endverbinder 30-serie End connector 30-series	Stuk / piece	126505