

BASISVERBINDING
BASE CONNECTOR

GV-02

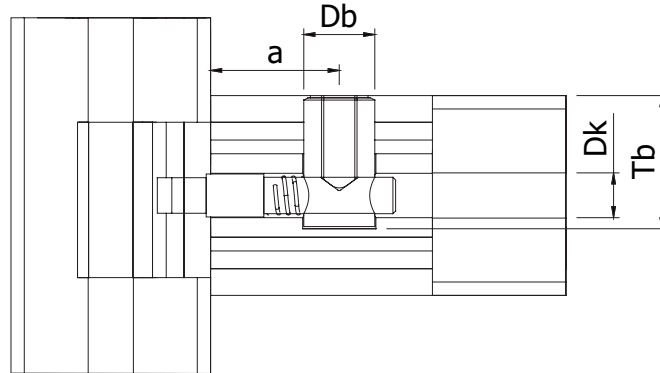
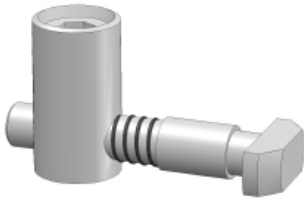

	a	Db	Dk	Tb
	29	Ø 14,2	Ø 10,2	26
	29	Ø 16,2	Ø 10,2	30

Bevat / consists:

- Hamerkopbout / hammerhead bolt
- Bus / sleeve
- Veer / spring
- Stelschroef / setscrew

Benodigde bewerkingen / required processes:

- Boring met diameter (Db), diepte (Tb) op afstand (a) / bore with diameter (Db), depth (Tb) at distance (a)
- Voor sleuf 8 dient de kern van het profiel vergroot te worden tot (Dk) / for groove 8 the core of the profile should be enlarged to (Dk)

Op aanvraag kunnen de bewerkingen door Boikon worden uitgevoerd / processes can be executed by Boikon on request

Toepassing / application

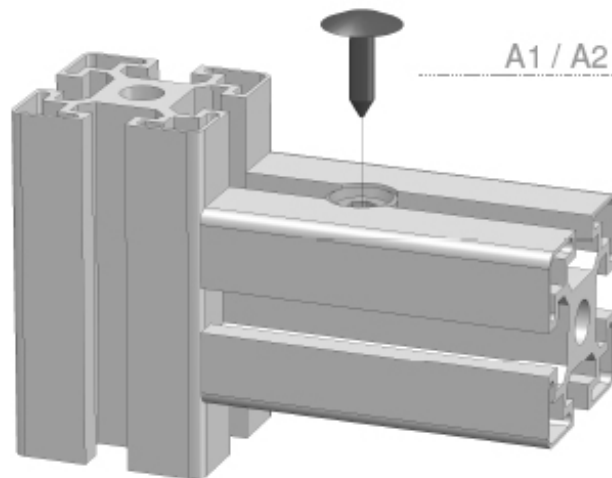

Afname / purchase	Korting / discount
... stuks / piece	
50 stuks / pieces	10%

	Omschrijving / description	Eenheid / unit	Art. code
	Basisverbinding 8 / GV-02 Base connector 8 / GV-02	Stuk / piece	128200
	Basisverbinding 10 / GV-02 Base connector 10 / GV-02	Stuk / piece	128205
	Accessoires / accessories	Eenheid / unit	Art. code
	A1 Afdekkap GV - zwart Cover cap GV - black	Stuk / piece	129000
	A2 Afdekkap GV - grijs Cover cap GV - grey	Stuk / piece	129005